

OPERATING GUIDE

And Technical Manual

TO HELP YOU ENJOY YOUR NEW

ZENITH

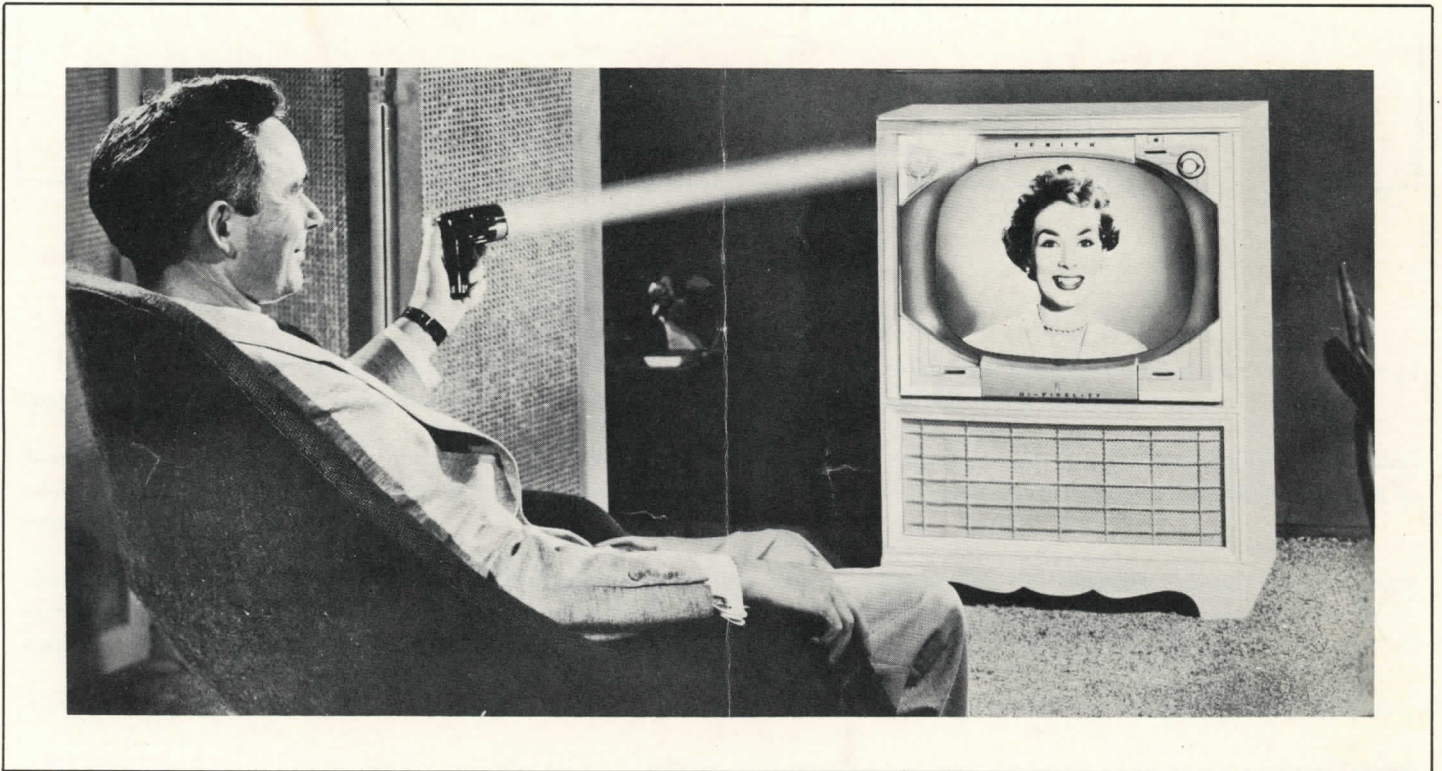

FLASH-MATIC

REMOTE CONTROL

IMPORTANT: Preserve This Manual for Future Use.



A FLASH OF LIGHT TUNES

YOUR ZENITH TV!

★ turns set on ★ turns set off ★ changes channels ★ shuts sound off during long, annoying commercials while the picture remains on the screen. All with just a flash of light.

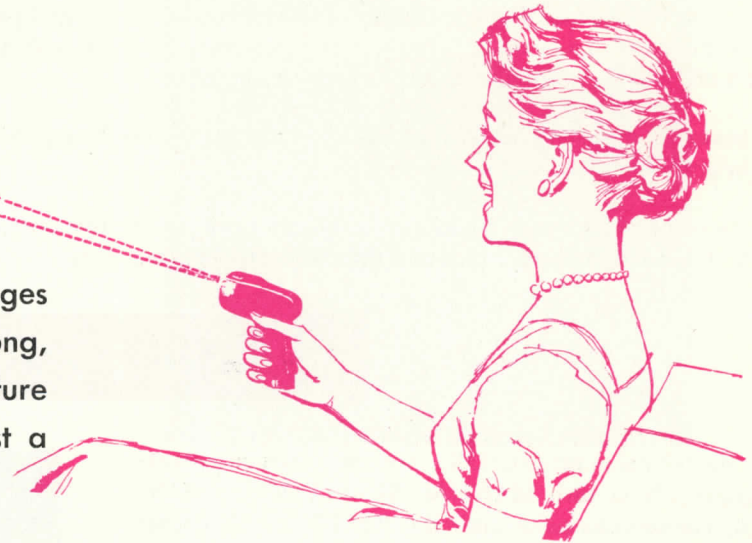

TELEVISION is being enjoyed by an ever increasing number of people throughout this great land of ours. From coast to coast, rural as well as urban areas now benefit from this relatively new medium of electronic entertainment.

Being a pioneer and a specialist in the field of electronics for over 36 years, Zenith has contributed a long list of exciting and exclusive features, all of which resulted from an unyielding desire to offer the consuming public better products to serve in more ways.

Outstanding examples of this are found in Zenith's tuning devices, which down through the years have led the entire industry in revolutionary design, greater accuracy, and more simplified operation. Starting back in 1923, with the first one-knob Radio tuning device, that abolished forever the confusion of multi-dial radio receivers.

This was followed by the famous automatic Pushbutton tuning, an operation so simple and accurate a child could operate.

Then came the famous Zenith Big Black Radio Dial and another step forward was made in easier, more simplified hand tuning.

Shortly following the introduction of Television, Zenith introduced the famous one-knob Bull's Eye TV Turret Tuner . . . a tuning device that did for television viewers what Zenith's one-knob tuning did for radio listeners over two decades before.

Just a few short years ago, Zenith developed the "Lazy Bones" Remote Control, a feature that would have been impossible to achieve without many years of research and experience in better tuning operation.

But this restless spirit of research, specialization and an insatiable desire for even easier TV tuning continued, and now, from Zenith, the greatest development of all . . . FLASH-MATIC Tuning.

Flash-Matic tuning is easy chair tuning, without wires, that automatically turns the TV set on and off, automatically selects stations and automatically turns sound on and off . . . all you have to do is sit back in your favorite chair and let a weightless and invisible extension of your arm perform the tuning functions, quick as a flash.

Introduction

This manual contains the operating instructions for the Zenith Flash-Matic Remote Control. In addition, a section for the technician gives a description, theory of operation, a parts list and the necessary instructions for maintenance of the control.

The Zenith Flash-Matic Remote Control was developed as an integral part of your Zenith television receiver to automatically control the set with a beam of light from any convenient location within viewing range of the screen. It will turn the receiver on and off, select stations and turn the sound on and off.

The beam of light is provided by a Flash-Gun furnished with the receiver; however, a good household flashlight can be used if its brightness and focus are comparable.

It is always best to keep fresh batteries in the gun for most effective operation of the system. To conserve the batteries, do not use the Flash-Gun for other purposes than to control the television receiver.

Preliminary Adjustments

Turn the television receiver ON. (See the television operating guide.) Next turn MANUAL SENSITIVITY CONTROL counter-clockwise until the RESET switch clicks; then turn it clockwise to about $\frac{2}{3}$ of its range. Be certain the AUTO-MANUAL SWITCH, located at the rear of the cabinet is in the AUTO position. Allow approximately $\frac{1}{2}$ minute warm-up time and set the receiver volume to the desired level and set the MANUAL SENSITIVITY CONTROL as described below.

The setting of the MANUAL SENSITIVITY CONTROL will depend upon the distance from which the receiver is to be operated, the condition of the batteries in the Flash-Gun and the amount of light in the room. At distances of 20 to 25 feet, set the control near its maximum clockwise position.

Adjustment must be below the point where the room light will actuate the unit. In some cases bright room light, or sunshine entering the room, may cause erratic operation. To prevent this it may be necessary to darken the room.

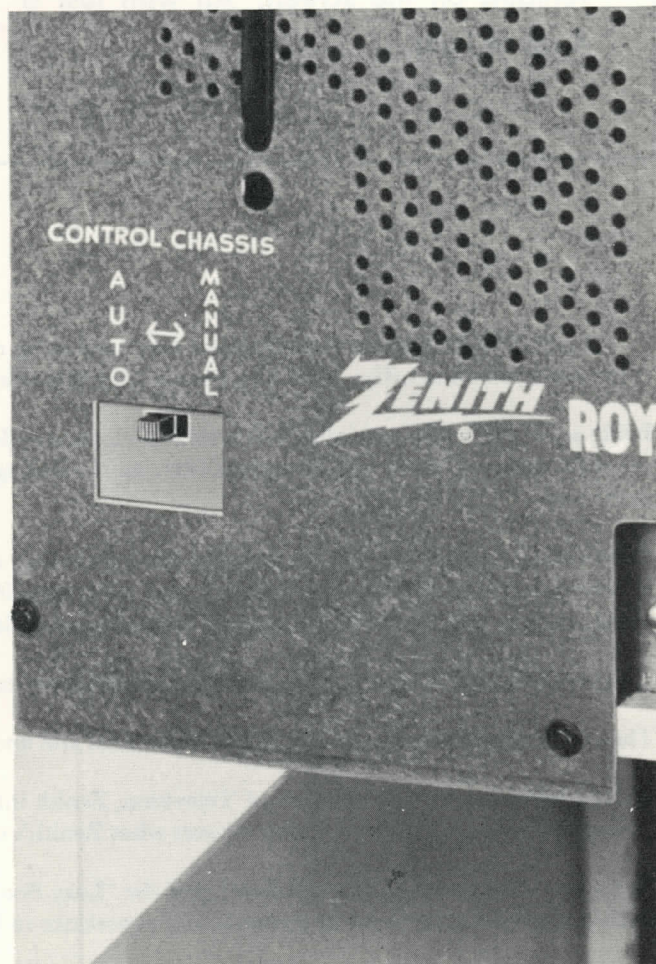
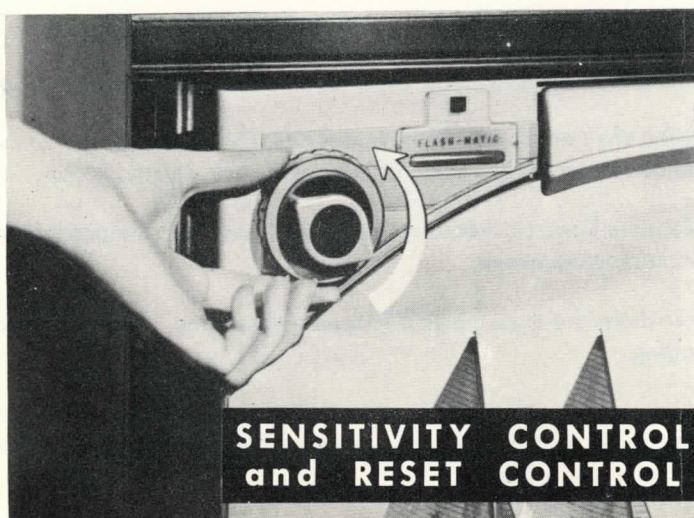

If, for any reason, it is desired to operate the receiver MANUALLY, set the AUTO-MANUAL SWITCH, on the back of the cabinet, to MANUAL position, then operate the set in the conventional manner.

Operation

Simply aim the beam of light from the Flash-Gun into the "slot" or window on the television escutcheon containing the control to be operated.

A flash of light of less than one second duration will operate any one of the controls.

TO TURN THE CHANNEL SELECTOR CLOCKWISE

beam the light through the upper right window.

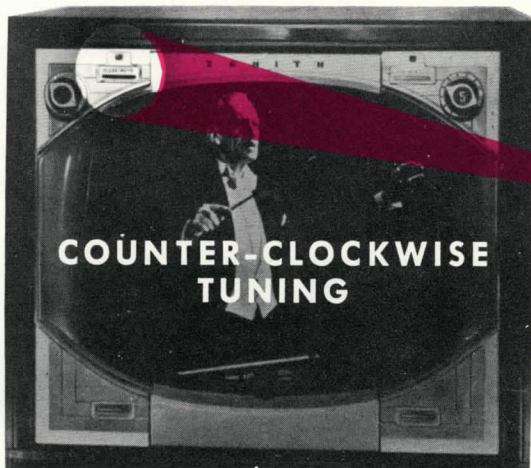
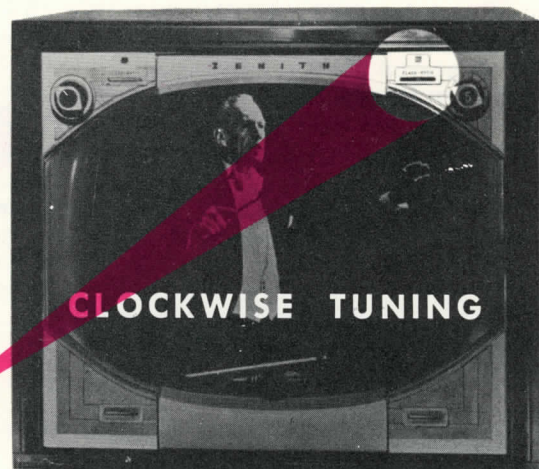

TO TURN THE CHANNEL SELECTOR COUNTER-CLOCKWISE

beam the light through the upper left window.

NOTE: A continuous beam of light will cause the channel selector knob to rotate in the same direction as long as the light is shining in the window. A little practice is required to learn where and how long to flash the light for all operations.

TO TURN THE SOUND OFF OR ON

beam the light through the lower right window.

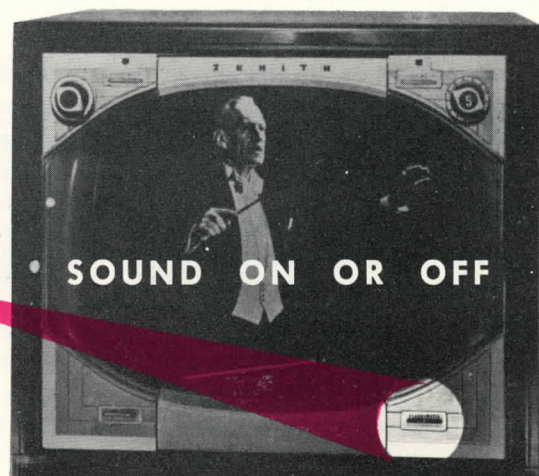

TO TURN THE RECEIVER OFF OR ON

beam the light through the lower left window. The Spot Light Channel Indicator will show if the receiver is turned on or off.

NOTE: When the receiver is turned OFF using light control, the channel selector photo-cells will not function.

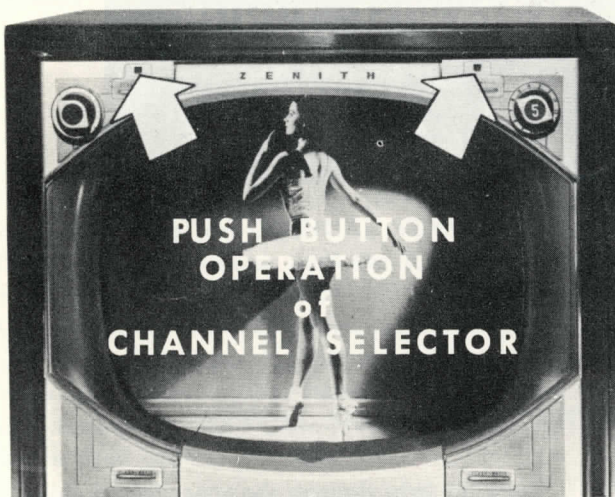

TO OPERATE THE STATION SELECTOR ELECTRICALLY WITHOUT THE BEAM OF LIGHT

push the button above the upper right window to turn the channel selector clockwise. Push the button above the upper left window to turn the selector counter-clockwise.

The manual ON-OFF switch, the center knob, functions as the **MASTER CONTROL**. With it, you can *completely* turn off the set and the Flash-Matic Control with absolute confidence that the receiver cannot turn itself on, regardless of the light which may strike the photocells.

 The jewelled light at the bottom of the TV cabinet will go out when this control is turned fully counter-clockwise indicating that both the TV receiver and Flash-Matic units are shut off.

IMPORTANT: Always turn off the Master Control when retiring or when the receiver is not to be used for a long period of time.



If the remote control cannot be made to function, push the **AUTO-MANUAL** switch to the **MANUAL** position (Page 1) and operate the television receiver manually. Consult your local Zenith dealer when service is necessary.

Technical Information

GENERAL

The Flash-Matic remote control consists of the following units:

- 1—Remote control chassis #S-22980 or S-23869
- 4—Photo-cells #162-1 or 162-2 or 162-3
- 1—Motor drive assembly #S-23300
- 1—Flash light gun #S-23151
- 2—Motor control switches #85-483
- 1—Sensitivity control, volume control and re-set switch assembly #S-23316

Four photo-electric control cells are positioned around the picture tube. (Fig. 1.) When a beam of light from the flash light strikes any one of these cells, the thyratrons and motor control tube actuate solenoids and relays for the various operations listed below:

- (A) Turn set "ON" or "OFF"
- (B) Mute the sound
- (C) Turn channel selector "clockwise"
- (D) Turn channel selector "counter-clockwise"

In addition, direct control of channel selector rotation is provided by two switches at the escutcheon top marked CW and CCW (Fig. 1).

A Manual Sensitivity Control (R-3) and Re-set Switch (SW-9) are located at the front of the TV cabinet in back of the TV receiver (ON-OFF) Volume Control knob (Fig. 1) and acts as a control for setting the sensitivity level of the photo-cells for maximum ambient light conditions that exist within the room. The marker on this control provides easy reference for proper setting and re-setting.

The Auto-Manual Switch is located at the control chassis rear (Fig. 1a). It is provided to disengage the control chassis and photo-cell circuits should manual TV operation be desired or in case the remote units are not functioning properly.

CONTROL SYSTEM

Block diagram (Fig. 2) shows the control system.

Four photo-cells PC-1, 2, 3 and 4 are employed as photo-electric controls.

Photo-electric cell PC-1 triggers thyatron control tube V1 (2D21) and its plate circuit solenoid controls the 117V AC power input to the TV receiver.

Photo-cell PC-4 triggers thyatron control tube V2 (2D21) and its plate circuit solenoid mutes the sound from the speaker.

Photo-cells PC-2 and PC-3 trigger motor control tube V3 (6BX7GT) and plate circuit relays K1 and K2 control the 117V AC applied to the motor for CW and CCW rotation. Additional switches SW5 and SW6 located at the top of the picture tube escutcheon provide direct control of motor rotation if desired.

Re-Set Switch (SW-9) is incorporated with Manual Sensitivity Control (R3) (Fig. 1) to allow manual reset control of the power (ON-OFF) and sound functions in addition to photo-electric control. The switch part is constructed to

make contact when the control is turned fully counter-clockwise. It is in series with switches on the AC—(ON-OFF) SW1 and (MUTE) SW2 switch assemblies which are actuated by the solenoids. Thus whatever the positions of solenoid switches SW1 or SW2, turning the control fully counter-clockwise will act as a manual re-set for the power (ON-OFF) and (MUTE) functions.

i.e. If the TV set sound was left in MUTE position when the TV receiver was manually turned off; the sound can be quickly brought back on again without the use of a flash light, by manually turning the Manual Sensitivity Control and Re-set Switch fully counter-clockwise until a "click" is heard and then back to the original setting.

A marker is provided on the control knob for quick reference of the original sensitivity setting. (Fig. 1.)

PHOTO-CELL

The four photo-cells used in the Zenith Flash-Matic Remote Control are semi-conductors which are extremely sensitive to light. The action of the cells to light energy is *resistive*. The resistance is an inverse function of light intensity and extremely high in the absence of light. With no light the crystal photo-cells may have as high as 100 megohms resistance and when strongly energized by light their resistance may drop as low as 25K ohms. (Fig. 5.)

VOLTAGE NETWORK

As shown in the schematic diagram (Fig. 6), the secondary winding of transformer T1 supplies 6.3 volts for the filaments of the tubes in the control chassis and 25 volts for the bias supply.

In addition, 120 volts is applied to the plates of the motor control tube V3 and 145 volts is applied to the thyatron plate circuits. Solenoid switches SW1 and SW2 are connected so that the thyratrons can only fire in sequence and never simultaneously. This arrangement prevents overload of the transformer and improves voltage regulation.

Selenium rectifier SE1 and capacitor C1 provide a minus 25 volts D.C. to bias the control tubes to cut off.

THYRATRON CONTROL CIRCUIT

The 2D21 thyatron is a gas filled tube and acts as a sensitive control device able to handle plate currents in the order of 100 milliamperes. (Fig. 3.) This feature enables its plate circuit to control switching devices such as the solenoids used in the Zenith Flash-Matic Remote Control. When the control grid is near zero, tube conduction occurs. The tube will continue to conduct until the plate voltage is removed or becomes negative and the control grid returned to a negative state. Since the plate voltage is AC the tube will stop conducting every time the AC swings negative.

The AC voltage applied to the tube plate and control grid are from the same source and are therefore in phase. Tube conduction occurs during the positive swing of this AC volt-

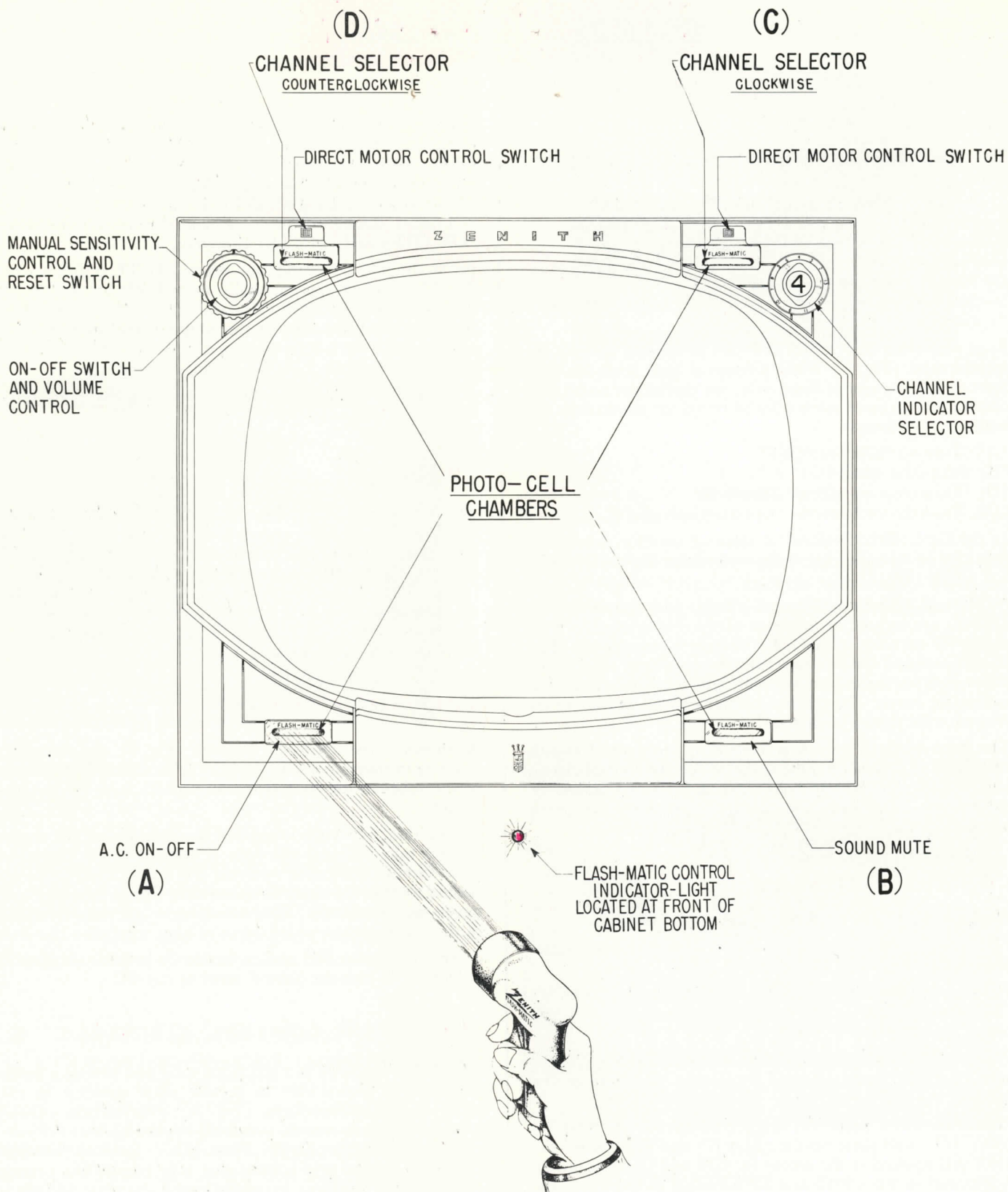

Fig. 1—Controls

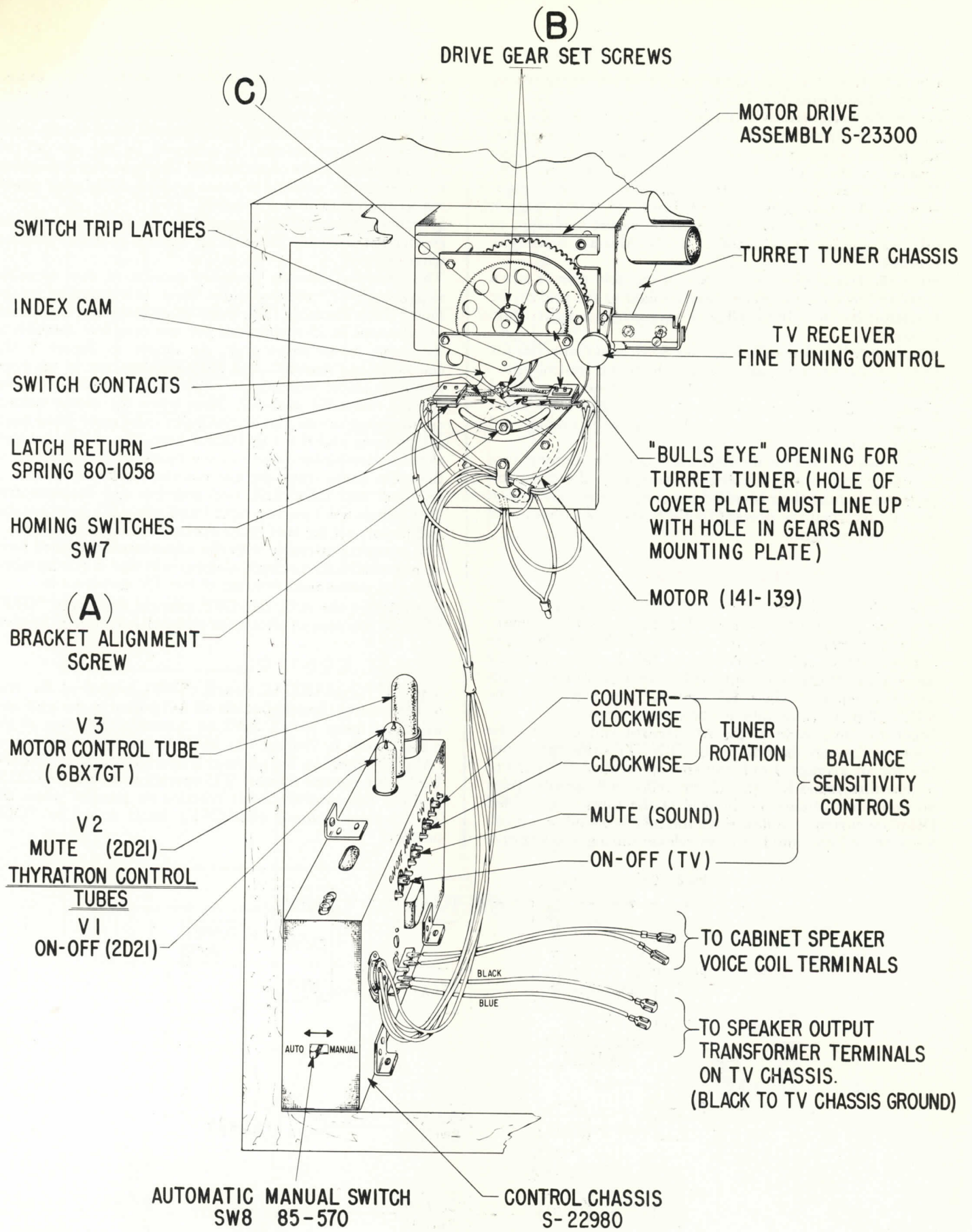

Fig. 1a—Rear View Control Installation

age. Therefore the plate circuit solenoids are energized by a rectified and pulsating DC voltage.

Due to the wide sensitivity range of crystal photo-cells, balance sensitivity controls R1, R2, R4 and R5 are individually placed in series with each cell to equalize the voltage applied to the grids of the control tubes. (Fig. 6.) The Manual Sensitivity Control R3 determines the voltage applied to all photo-cells. The amplitude of this voltage is approximately 90V AC, but it may be varied from zero to full line voltage by adjustment of the Manual Sensitivity Control.

Since the crystal photo-cell acts as a variable resistor when energized by light the AC voltage applied to the grid of the thyatron by the photo-cell will vary when a light beam strikes it.

Autoformer T1, Selenium Rectifier SE-1, and Capacitor C1 form a negative bias supply for the thyatron control grid. When the amplitude of the AC voltage from the crystal photo-cell applied to the thyatron control grid approaches or exceeds the zero bias point, the tube will conduct and control occurs.

Re-set switch SW9 on the Manual Sensitivity Control momentarily applies a 110 Volt pulse voltage to the thyatron grids overcoming their bias and resulting in the same action that occurs when the power ON-OFF and mute photo-cells are excited by light.

MOTOR CONTROL CIRCUIT

The action of the motor control circuit is similar to the thyatron action just described (Fig. 4). Since the mechanical requirements to operate switches SW-3 and SW-4 are not as great as switches SW-1 and SW-2 and momentary contact and release are required for circuit operation, regular plate current relays K1 and K2 are used with the 6BX7GT dual triode tube in the control circuit.

When the amplitude of the AC control voltage from the photo-cell swings the grid of the 6BX7GT sufficiently positive for an average 9 milliamperes of rectified DC current to flow thru relays K1 and K2, the relays will operate. With no excitation voltage on the grid of the tubes, no rectified DC plate current will flow since the tube is biased to cut off. Since the relays would tend to release during the negative

swings of the AC voltage and cause "chatter", filter capacitors C4 and C5 are placed across them to smooth out this pulsating voltage, resulting in a positive holding action.

A 117 volt AC induction type motor is used in the drive assembly. Motor reversal is achieved by the use of two windings and a series capacitor C6. This capacitor is switched to either motor winding to cause a phase differential resulting in change of motor rotation.

Switches SW5 and SW6 mounted on top of the picture tube escutcheon assembly allow direct control of motor rotation when desired.

The "homing" switch assembly consists of two identical switches (SW7) and two index cams. It is mounted on the motor drive assembly. The index cams make one revolution per channel or 13 revolutions per one complete rotation of the large motor drive gear. As shown in Figure 5 the cams are in "neutral" and both switches are in an open position. These switches are electrically across the motor control relays K1 and K2. Thus when the motor control circuit relays are energized, the index cams move from neutral position and the trip latches keep the switch contacts closed, maintaining power to the motor for the balance of the cycle. Since clockwise and counter-clockwise rotation is required two cams and two switches are incorporated. The switch SW7 on the right hand side (C) is adjustable and factory set for best index operation. (Figs. 1a and 5.)

The complete assembly with the adjustments provided form an electrical and mechanical drive unit that is synchronized with the mechanical rotation of the TV turret tuner.

NOTE: When the A.C. ON-OFF solenoid SW1 is in "OFF" position, the control circuit for channel selection is inactive.

POWER CONTROL

The AUTO-MANUAL switch (SW8) located at the rear of the control chassis controls all AC power to the unit and by-passes mute switch SW2 to assure audio even if the mute switch is "locked" in MUTE position. It is set to "AUTO" position for photo-cell operation and to "MANUAL" for normal manual TV operation. In the "AUTO" position the control circuit remains on standby when the TV receiver volume (ON-OFF) knob is set to "ON" position.

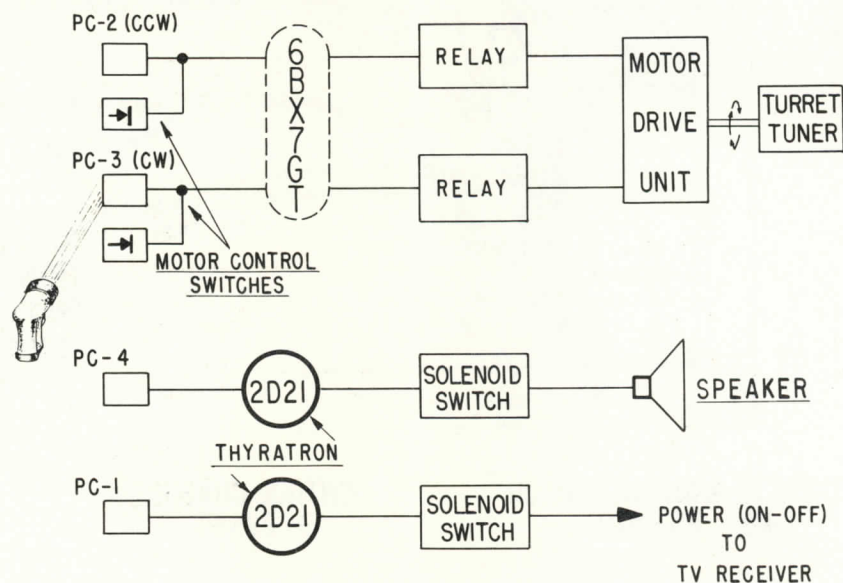

Fig. 2—Block Diagram of Control System

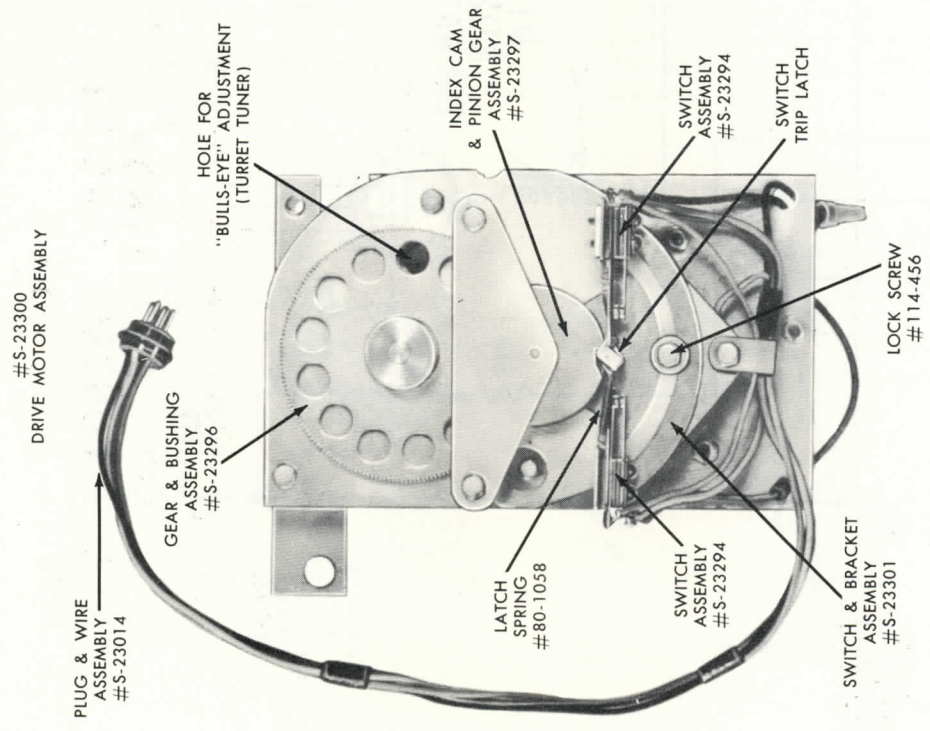
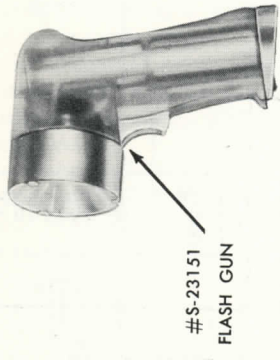
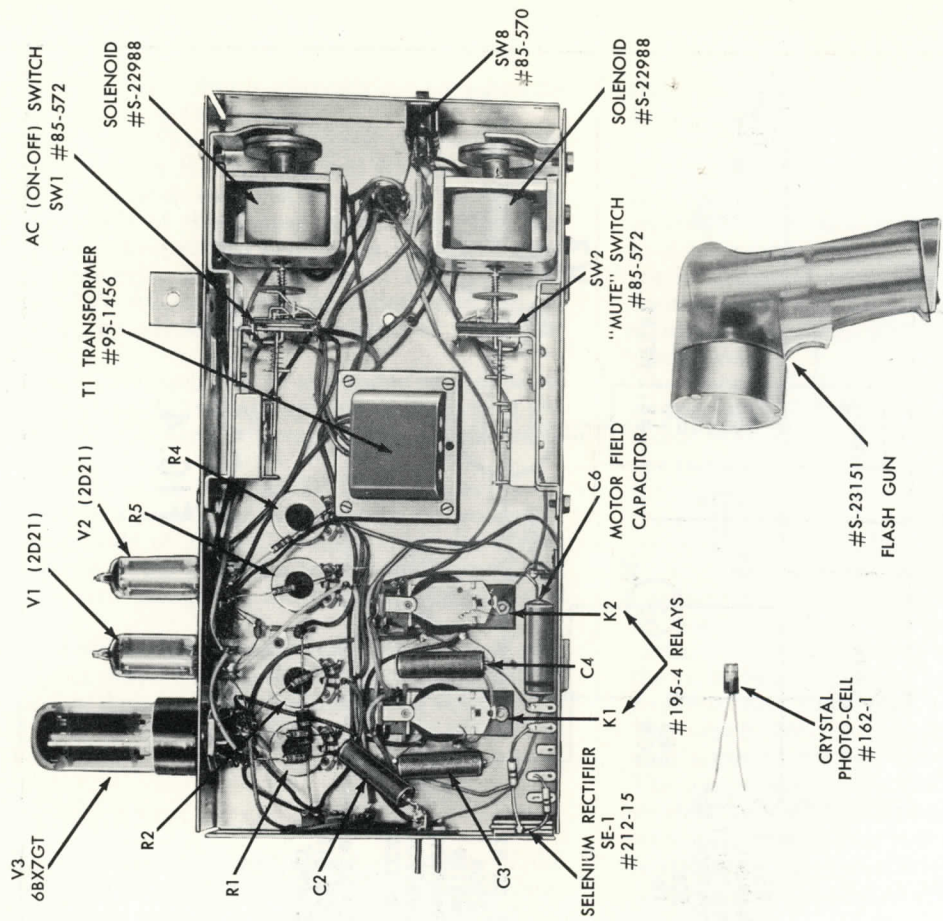
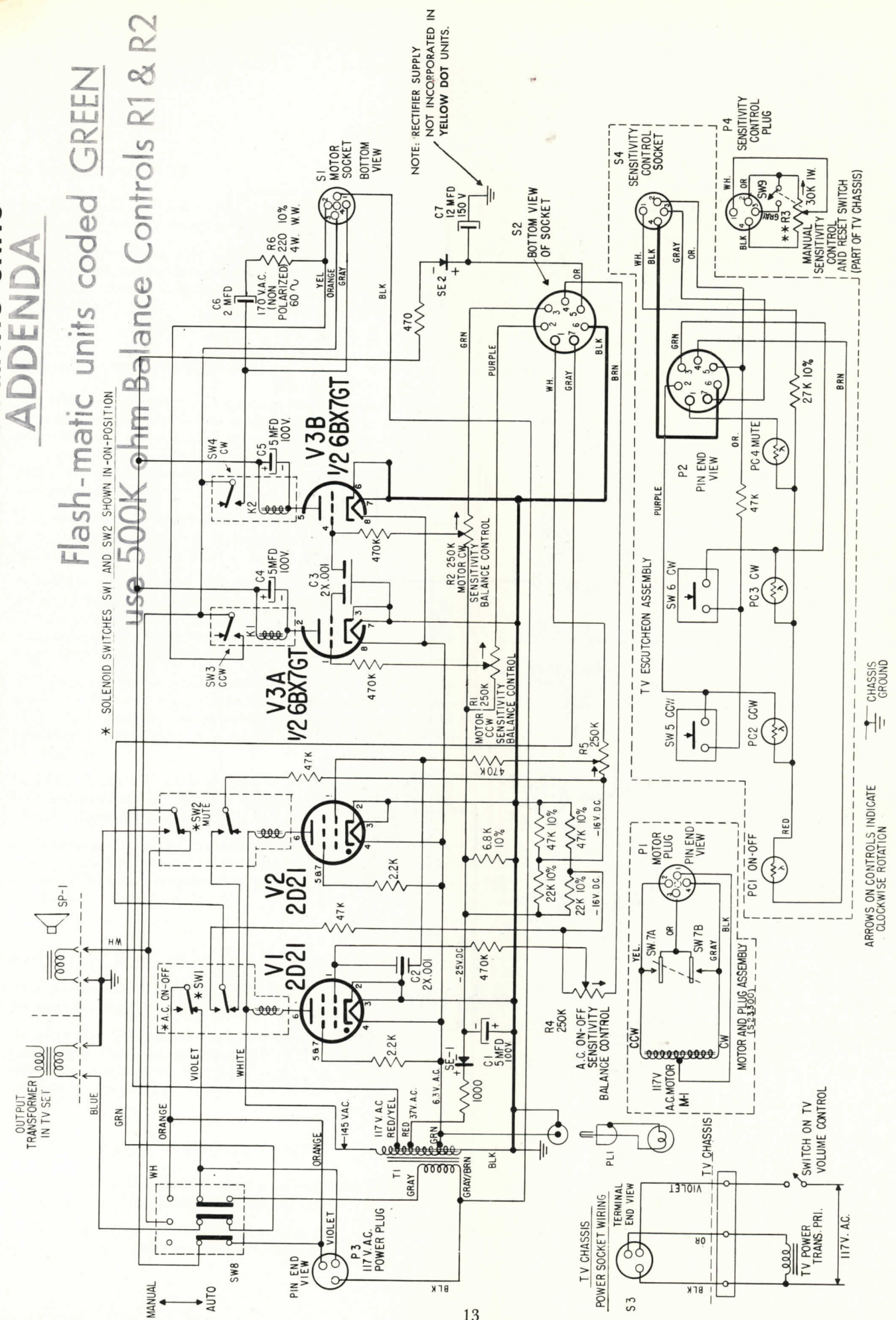

Fig. 5—View Showing Control Chassis, Motor Drive Assembly, and Flash Gun

YELLOW DOT OR YELLOW-BLUE DOT CODE FLASH-MATIC UNITS ADDENDA

Flash-matic units coded **GREEN**
use **500K ohm** Balance Controls R1 & R2



** R3 FRONT SECTION PART OF
63-3582 ON 22X200 AND 22X210 TV CHASSIS
63-3581 ON 19X220 TV CHASSIS.

Fig. 6—Schematic Diagram

RED DOT CODE FLASH-MATIC UNITS

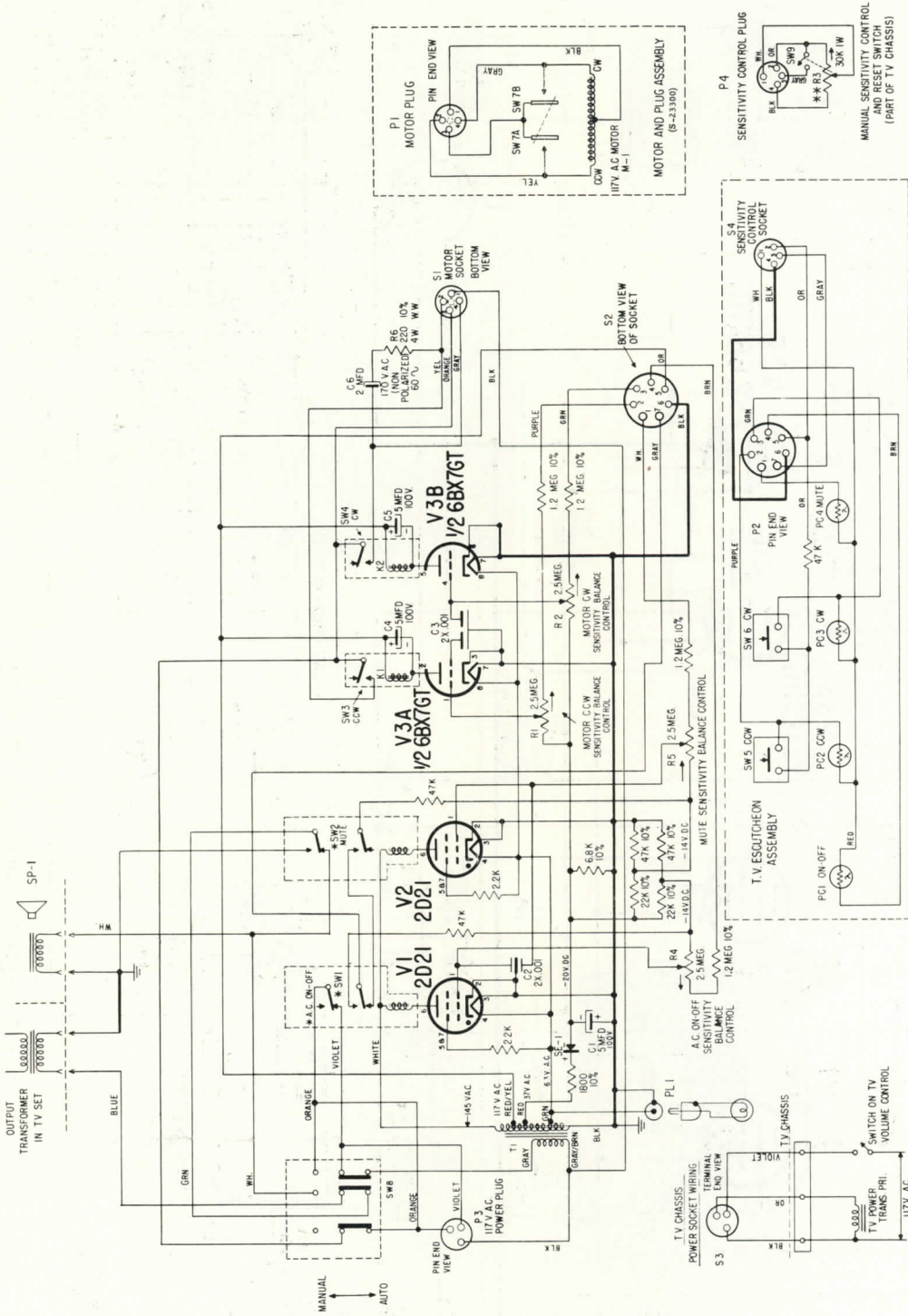

NOTES. THIS CHASSIS BEARS A RED CODE DOT ON THE OUTSIDE OF THE CHASSIS ADJACENT TO THE AUTO-MANUAL SWITCH SW8

* SOLENOID SWITCHES SW1 AND SW2 SHOWN IN ON-POSITION.

** R3 FRONT SECTION INDICATE CLOCKWISE ROTATION

63-3582 ON 22X200 AND 22X210 TV CHASSIS

63-3581 ON 19X220 TV CHASSIS

Fig. 7.

MEASUREMENTS

An AC voltmeter (preferably a vacuum tube type) is recommended when measuring AC voltages.

Use a DC milliammeter when reading currents thru the relays or solenoids. A vacuum tube voltmeter or a 20K ohms/volt meter is recommended for DC bias voltage measurements.

LIGHT CONDITIONS

For effective control it is important that the flash light be in good working condition. A dim light due to weak batteries or poor focus caused by a defective bulb will result in poor operation. Replace weak batteries when necessary and check to see that the "light spot size" is small to insure a concentrated beam.

It is important to locate the TV receiver within the room so that direct or diffused sunlight or light from lamps will not strike the photo-cells.

Accidental operation of the photo-cells can also occur by reflected light from a mirror, white garment, or highly reflective object within the room. To eliminate or minimize this undesirable effect the location of the TV set within the room should be made carefully.

Re-adjusting the Manual Sensitivity Control will help to minimize this effect at a sacrifice to photo-cell sensitivity (Fig. 1). If possible, the reflected light condition should be eliminated rather than to readjust the Manual Sensitivity Control.

NOTE: If the TV set is located in an elevated position, it will be necessary to tilt the cabinet forward slightly for effective light control.

In locations where the prevailing light conditions are very low, the sensitivity level of the Flash-Matic system can be increased by advancing the four balance sensitivity controls clockwise.

PHOTO-CELL REPLACEMENT

The photo-cells PC1, PC2, PC3, PC4, can be replaced if necessary without removal of the TV chassis.

Remove the TV cabinet back and from the cabinet inside carefully unclip both pig-tail leads of the photo-cells from the Fahenstock clips. Carefully work out the photo-cells without putting undue strain on the leads.

LIGHT LEVEL ADJUSTMENTS

Should it be necessary to re-set the adjustments of the control chassis, the following procedure is recommended.

1. Turn all balance sensitivity controls (R1, R2, R4 and R5) to maximum counter-clockwise position.

2. The long blue lead stapled inside of the cabinet (right side from cabinet back) connects to the center lug of the Manual Sensitivity Control.

Connect an A.C. Voltmeter between this blue lead and chassis ground. Set the Manual Sensitivity Control to where the meter reads 74 volts A.C.

3. Darken the room and remove the shade from a lamp using a 60 watt bulb. Position the lamp about 4 feet from the TV cabinet front so that the light completely illuminates the face of the photo-cell and place masking tape temporarily over the remaining 3 photo-cells. Adjust the corresponding balance sensitivity control.
4. Similarly adjust each of the photo-cell sensitivity balance controls to a point just below the triggering level.

Note that increasing the rotation of the balance sensitivity control clockwise increases the sensitivity. (Figs. 1a and 6.)

CHANNEL INDEXING (Figs. 1a and 5)

Improper TV channel selection can be caused by incorrect indexing of the motor drive unit.

If the unit does not index, carefully reset the alignment bracket by loosening screw (A), re-position bracket and re-tighten screw securely. (Figs. 1a and 5.)

If resetting the alignment bracket (A) fails to remedy indexing troubles, a finer adjustment can be made by resetting switch SW7 located on the right hand side (C). (Fig. 1a.) Slightly loosen both holding screws of the switch and move switch assembly further or closer to the left side switch. (Figs. 1a and 5.) Re-tighten holding screws.

It is important that the drive gear holes line up with the holes of the cover plate and the mounting plate providing for insertion of a "Bulls-Eye" alignment wrench to the turret tuner. Therefore if mis-alignment exists, turn the channel selector knob at the front of TV set to exactly "on station", and loosen both set screws (B) about 3 turns. Remove the 3 mounting screws of the motor unit. Slide entire assembly outward until the gear is free of the shaft. Carefully re-position the gear so that the "Bulls eye" holes are in line when the two "homing" switches and cams are in neutral position (switch contacts open). Re-tighten set screws (B) and re-mount complete assembly using the 3 original mounting screws.

LOCALIZING TROUBLE

To localize trouble set the AUTO-MANUAL switch to "AUTO" position and actuate or push the relays or solenoids with an insulated screwdriver. If doing this results in proper control, the trouble is ahead of these circuits, such as defective tubes or photo-cells. However, if the mechanical

movement suggested has no effect on control operation, it indicates trouble beyond that point, such as switch or motor trouble. Check all cable and plug connections. (Fig. 5.)

DEFECTIVE ON-OFF AND SOUND OPERATION

Improper AC (ON-OFF) or mute operation can sometimes be caused by poor contact connection of switches SW1 and SW2 located in the control chassis. Check the contacts to see that they are "making" and "breaking" properly. If necessary, replace defective switches. (Fig. 5.)

Sometimes the switching action can be improved by re-setting the switch carriage assembly. This is easily done by loosening the two holding screws, re-setting the carriage, and re-tightening the screws.

LUBRICATION

If the solenoid assemblies tend to mechanically "stick", apply lubri-plate to the solenoid plunger shafts where they enter the coil frames, ride on the switch brackets, and pass thru the eyelets in the switch pressure plate (Fig. 5). Also apply a small amount of lubri-plate to the motor drive gears.

COLOR CODING ON FLASH-MATIC UNITS

YELLOW DOT OR YELLOW-BLUE DOT CODE FLASH-MATIC UNITS

A. YELLOW DOT CODE

NOTE: A YELLOW DOT is marked near the AUTO-MANUAL SWITCH of the control chassis and on the back of the escutcheon mask assembly. The input grid circuits of control tubes V1, V2 and V3 were changed as follows:

1. The series 27K resistor to the arm of the Manual Sensitivity Control and the series 15K resistors of the V3 grid circuit are omitted.
2. Series 470K resistors are inserted between the control grids of V1, V2, V3A-V3B and the arms of their related sensitivity balance control potentiometers R1, R2, R4 and R5.
3. Each photo-cell connects directly to one side of the sensitivity balance controls.
4. The 100K resistor of the motor control switches is reduced in value to 47K.

B. YELLOW AND BLUE DOT CODE

NOTE: A YELLOW DOT and a BLUE DOT are marked near the AUTO-MANUAL switch of the control chassis and on the back of the escutcheon mask assembly of units containing both the changes mentioned in (A) and the addition of a rectifier-filter circuit. (See Fig. 6.)

Units marked with the yellow and blue dots are adaptable to use either photo-cell #162-1 or photo-cell #162-2.

NOTE: For replacement use Photo-Cell #162-1 on units having a yellow dot, a yellow and blue dot, or no color coding. Use Photo-Cell #162-2 on units with a blue and yellow dot only.

RED DOT CODE FLASH-MATIC UNITS

C. RED DOT CODE

NOTE: A RED DOT is marked near the AUTO-MANUAL switch of the control chassis and on the back of the escutcheon mask assembly.

These units do not contain a rectifier-filter circuit and the grid bias voltages to the control tubes are different. (See Fig. 7.)

For photo-cell replacement use only type #162-3.

IMPORTANT: Do not interchange control chassis or escutcheon mask assemblies of different color coding.

Parts List

DRIVE MOTOR ASSEMBLY S-23300

Ref. Symbol	Part No.	Description
	12-2261	Switch mounting bracket
	17-141	Nylon clamp
	23-23	Wire connector
	57-2157	Pinion bearing plate
	58-226	Five prong plug
	80-1058	Latch spring (2 used)
	83-2462	Insulating strip
	94-851	Bushing

Ref. Symbol	Part No.	Description
	114-456	8-32 x 1/4 hex hd. M.S. steel cadmium (flat washer att.)
	141-139	Drive motor
	S-23011	Gear & pinion assembly
	S-23013	Mounting plate assem. staking
	S-23209	Gear & pinion assembly
	S-23294	Switch assembly (2 used)
	S-23296	Gear, bushing & set screw assem.
	S-23297	Cam & pinion gear assembly
	S-23298	Cover plate & bushing assembly

Ref. Symbol	Part No.	Description
	S-23299	Output gear & bushing assembly
	S-23302	Coupling shaft & set screw assembly

CONTROL CHASSIS ASSEMBLY S-22980

	12-2243	Switch bracket (2 used)
	12-2244	Mounting bracket (2 used)
	22-2056	Electrolytic capacitors 12MFD 150VDC
C2	22-2553	2 x .001 mfd. ceramic disc capacitor (2 used)
C1, C4, C5	22-2696	Electrolytic capacitor (3 used)
C6	22-2708	Motor capacitor—2 MFD—170V AC
	58-207	Three prong plug
R7	63-1071	10,000 ohm carbon resistor 1W. 10%
	63-1772	470 ohm 1/2 W. 20%
R15, R16	63-1800	2,200 ohm carbon resistor 1/2 W. 20%
R8	63-1820	6,800 ohm carbon resistor 1/2 W. 10%
R13, R14	63-1835	15,000 ohm carbon resistor 1/2 W. 20%
R9, R11	63-1841	22,000 ohm carbon resistor 1/2 W. 10%
R10, R12	63-1855	47,000 ohm carbon resistor 1/2 W. 10%
R1, R2, R4, R5	63-3576	Sensitivity Control
R3	63-3582	Manual Sensitivity Control
	69-64	2-56 x 1/4 Rd. Hd. M.S. steel nickel plate (4 used)
	78-644	Connector socket
	78-755	Octal tube socket
	78-806	Miniature 7 contact wafer tube socket (2 used)
	78-792	Five contact wafer socket
	78-1036	Five contact molded socket
	80-1053	Compression spring (2 used)
	83-496	4 lug terminal strip
	83-1192	Single lug terminal strip
	83-2341	Terminal strips (2 used)
	83-2438	Insulating strip (2 used)
	83-2440	Spacer strip (2 used)
	83-2447	Insulating strip
SW2	85-572	Switch S.P.S.T.
SW1	85-572	Switch D.P.S.T.
SW8	85-254	Slide switch T.P.D.T.
SW9	85-573	Re-set switch S.P.S.T.
	86-275	Terminal (2 used)
	93-2	Brass washer
T1	95-1456	Transformer
K1, K2	195-4	Relay—S.P.D.T. (2 used)
SE-1	212-15	Selenium rectifier
SE-2	212-16	Selenium rectifier
	S-22980	Final chassis assembly
	S-22984	Shaft assembly (2 used)
	S-22985	Plunger assembly (2 used)
	S-22987	Plunger assembly (2 used)
	S-22988	Coil & plate assembly (2 used)
V1, V2	Vacuum Tube—Type 2D21	
V3	Vacuum Tube—Type 6BX7GT	

CONTROL CHASSIS ASSEMBLY S-23869 (Same as S-22980 except for following parts)

Ref. Symbol	Part No.	Description
	63-1796	1,800 ohm carbon resistor 1/2 W. 10%
	63-1915	1.2 megohm carbon resistor 1/2 W. 10%
	63-3599	220 ohm wire wound resistor 4W. 10%
	63-3611	Sensitivity control (4 used)
	85-254	Slide switch T.P.D.T.

CHASSIS (19X22) ESCUTCHEON & CABLE ASSEMBLY MODELS X2264RQ, X2664EQ

	19-286	Cable clip—Tinnerman
	19-287	Cable clip—Tinnerman
	24-749	Photo cell cover (4 used)
	83-2443	Photo cell cover strip—bottom (2 used)
	114-248	6-20 x 5/16 Hex hd. self-tap. screw (8 used)
	114-69	4-40 x 1/4 Hex hd. M.S. (2 used)
	114-609	4-24 x 5/16 Hex hd. self-tap. screw (8 used)
	63-1856	47K ohm 1/2 W. ins. 20%
	83-2449	Photo cell mtg. strip (4 used)
	85-389	Push switch (2 used)
	114-409	4-24 x 5/16 Hex hd. self-tap.
	125-61	Rubber grommet (4 used)
	24-772	Upper cover
	24-752	Control cover
	40-169	Lower left hand hinge
	40-170	Lower right hand hinge
	40-171	Upper left hand hinge
	40-172	Upper right hand hinge
	46-1406	Knob (glass retaining strip)
	57-1725	Emblem plate
	57-2144	Escutcheon
	80-1054	Cover spring—bottom
	80-1055	Cover spring—top
	83-2450	Glass retaining strip
	162-1	Photo-cell (4 used)
	or 162-2	Photo-cell (4 used)
	or 162-3	Photo-cell (4 used)
	188-150	Retaining ring (2 used)

CHASSIS (22X20, 22X21) ESCUTCHEON & CABLE ASSEMBLY MODELS X2365EQ-RQ, X2391EQ, X2674EQ-RQ

	17-135	Plastic clamp
	24-749	Photo cell cover
	24-772	Upper cover
	24-752	Control cover
	40-169	Hinge—Lower left
	40-170	Hinge—Lower right
	40-171	Hinge—Upper left

Ref. Symbol	Part No.	Description
	40-172	Hinge—Upper right
	46-1406	Knob (glass retaining strip) (2 used)
	54-12	6-32 x 5/16 x 7/64 hex nut (4 used)
	54-349	10-32 Nut
	54-405	Speed nut—Tinnerman (12 used)
	57-1725	Emblem plate
	57-2149	Die cast escutcheon
	58-169	7 prong plug
	63-1845	27K ohm 1/2 W. ins. 10%
	63-1870	100K ohms 1/2 W. ins. 20%
	66-104	Yoke mtg. rod (4 used)
	78-1044	4 contact socket & wire
	80-889	C.R. tube gnd. spring
	80-1054	Cover spring—Lower
	80-1055	Cover spring—Upper
	80-1056	Gnd. spring
	82-65	C.R. tube mtg. strap (4 used)
	83-1662	5 lub terminal strip
	83-2442	Photo cell cover strip—Top (2 used)
	83-2443	Photo cell cover strip—Bottom (2 used)
	83-2448	Reinforcing strip
	83-2449	Photo cell mtg. strip (4 used)
	83-2450	Glass retaining strip
	83-2503	Photo-cell mounting strip (G.E. photo-cell)
	85-389	Push switch (2 used)
	93-125	#6 internal shakeproof lockwasher (4 used)
	93-842	.062 x .187 x 9/16 steel washer
	93-1200	Insulating washer
	94-872	Rubber bushing (8 used)
	95-1445	Deflection yoke
	97-444	Threaded stud (2 used)
	112-88	8-32 thumb screw

Ref. Symbol	Part No.	Description
	114-248	6-20 x 5/16 hex hd. self-tap. screw (2 used)
	114-351	6-20 x 1/2 hex hd. self-tap. screw (8 used)
	114-409	4-24 x 5/16 hex hd. self-tap. screw (8 used)
	114-431	8-18 x 1/4 hex hd. self-tap. screw (6 used)
	114-442	8-32 x 5/16 hex hd. self-tap. screw—flat washer att. (2 used)
	114-467	10-32 x 1/2 hex hd. self-tap. screw—flat washer att. (4 used)
	114-482	10-32 x 2 1/2 x 5/16 hex hd. mach. screw
	114-494	10x16 x 1/2 hex hd. self-tap. screw—flat washer att. (4 used)
	125-61	Rubber grommet (4 used)
	162-1	Photo electric cell (4 used)
	or 162-2	Photo-cell (4 used)
	or 162-3	Photo-cell (4 used)
	166-79	Rubber bumper (4 used)
	166-82	Rubber bumper (4 used)
	188-184	C.R. tube mtg. ring
	199-199	Protective sleeve

MISCELLANEOUS

	S-23151	Flash Gun
	S-61	Flash Gun Batteries (2 used)
	100-195	Flash Gun Bulb
1	78-1050	Pilot Light Socket, Wire & Plug
1	83-1220	Pilot Light Socket, Mtg. Strip
1	90-367	Pilot Light Tube
1	100-67	Pilot Light Bulb—Mazda #47
1	171-7	Pilot Light Lens



ZENITH RADIO CORPORATION

6001 Dickens Avenue

Chicago 39, Illinois